

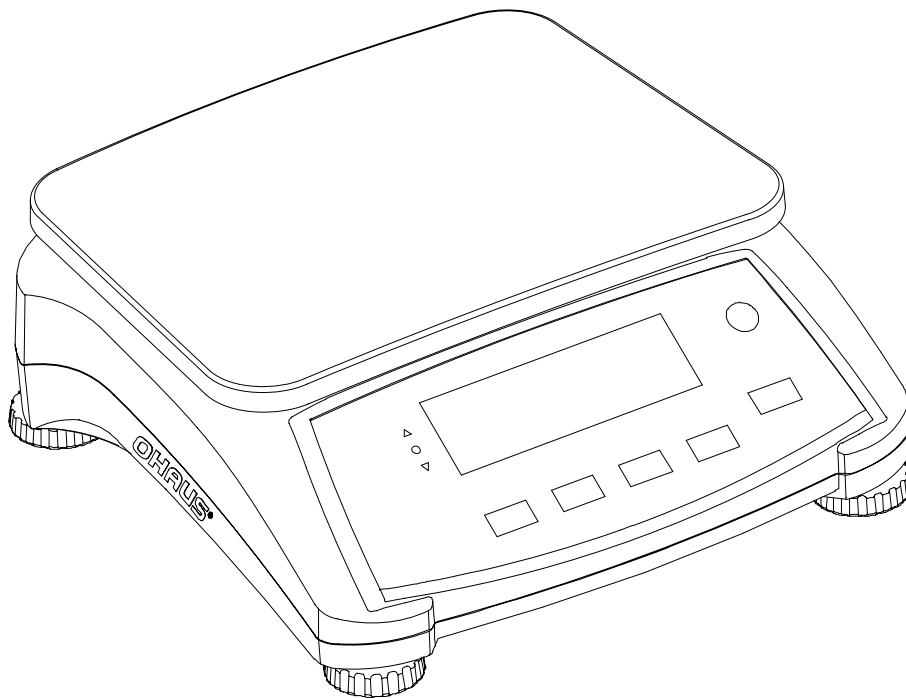

Ranger™ 3000 Series Instruction Manual



1. INTRODUCTION

This manual contains installation, operation and maintenance instructions for the Ranger™ 3000 Series. Please read the manual completely before using the scale.

1.1 Definition of Signal Warnings and Symbols

Safety notes are marked with signal words and warning symbols. These show safety issues and warnings. Ignoring the safety notes may lead to personal injury, damage to the instrument, malfunctions and false results.

Signal Words

CAUTION for a hazardous situation with low risk, resulting in damage to the device or the property or in loss of data, or injuries if not avoided.

Note (No symbol)
For useful information about the product

Warning Symbols



Attention Symbol



Alternating Current

1.2 Safety Precautions

Please follow these safety precautions:

- Verify that the AC input voltage printed on the data label matches the local AC power supply.
- Do not drop loads on the platform.
- Make sure that the power cord does not pose a potential obstacle or tripping hazard.
- Do not position the scale in a way that makes it difficult to pull the power plug.
- Use only approved accessories and peripherals.
- Operate the scale only under ambient conditions specified in these instructions.
- Disconnect the scale from the power supply when cleaning.
- Do not operate the scale in hazardous or unstable environments.
- Do not immerse the scale in water or other liquids.
- Do not place the scale upside down on the platform.
- Only use weights within the scale's capacity as specified in these instructions.
- Service should be performed only by authorized personnel.

2. INSTALLATION

2.1 Package Contents

- Scale
- Pan
- Sub-platform
- Power Cord
- Instruction Manual / CD
- Weigh Below Hook
- Warranty Card

2.2 Installing Components

Install the sub-platform and metal pan as shown below. Press to lock the sub-platform into place.

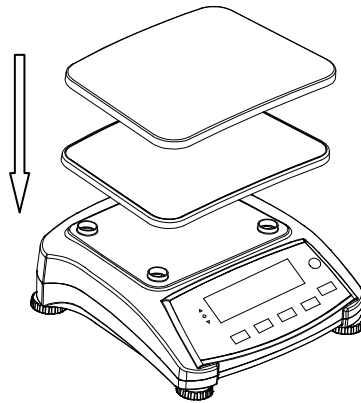

Figure 2-1. Installing sub-platform and metal pan

2.3 Selecting the Location

Use the scale on a firm, steady surface. Avoid locations with excessive air current, vibrations, heat sources or rapid temperature changes. Allow sufficient space around the scale.

2.4 Leveling the Equipment

The Ranger Series has a level indicator as a reminder that the scale should be leveled for accurate weighing. There is a level bubble in a small round window on the front of the scale. To level the scale, adjust the feet so the bubble is centered in the circle. Be sure the equipment is level each time its location is changed.

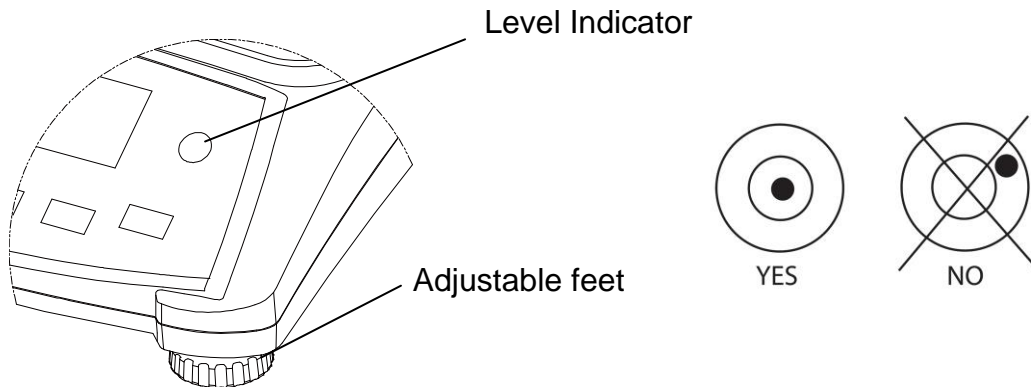

Figure 2-2. Level indicator

2.5 Connecting Power

AC power is used to power the scale when battery power is not needed. First, connect the AC power cord (supplied) to the power input jack then connect the AC plug to an electrical outlet.

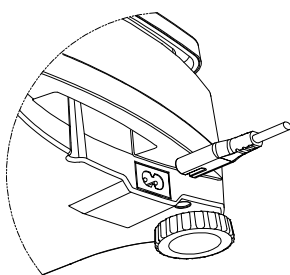

Figure 2-3A. Connect the power plug to the input jack on the back of scale.

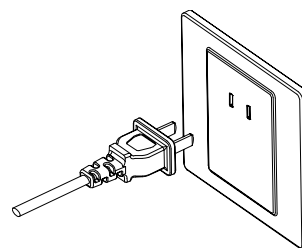

Figure 2-3B. Connect AC power plug to the proper AC supply.





2.5.1 Battery Power:

The scale can be used on AC power immediately. Allow the battery to charge for 12 hours before using the scale on battery power. The Scale will automatically switch to battery operation if there is a power failure or the power cord is removed. With AC power, the scale is constantly charging, so the battery charge indicator (see item 10 in table 3-2) will remain lit. The scale can be operated during charging, and the battery is protected against overcharging.

For maximum operating time, the battery should be charged at room temperature.

During battery operation, the battery symbol indicates the battery charge level remaining. The indicator will automatically turn off when the batteries are fully charged.

TABLE 2-1

Symbol	Charge level
	0 to 10 % Remaining
	11 to 40 % Remaining
	41 to 70 % Remaining
	71 to 100 % Remaining

Notes:

When battery symbol blinks fast, approximately 30 minutes working time is left.

When [Lo.BAt] is displayed, the scale will shut off.

Charging the scale must be performed in a dry environment.



CAUTION: Battery is to be replaced only by an authorized Ohaus service dealer. Risk of explosion can occur if the rechargeable battery is replaced with the wrong type or if it is not properly connected. Dispose of the lead acid battery according to local laws and regulations.

3. OPERATION

3.1 Controls

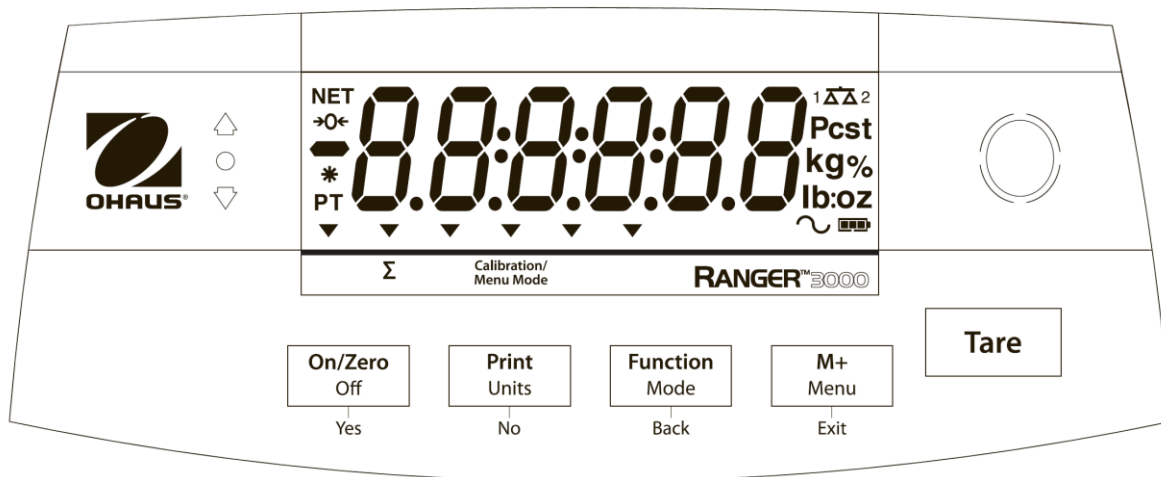

Figure 3-1. Ranger 3000 Control Panel with LCD display

TABLE 3-1. Button Functions

Button	On/Zero Off Yes	Print Units No	Function Mode Back	M+ Menu Exit	Tare
Primary Function (Short Press)	On/Zero Turns the scale on If scale is On, sets Zero	Print Sends the current value to the selected COM ports if AUTOPRINT is set to Off.	Function Initiates an application mode.	M+ Accumulates the weight or displays the accumulated information at 0 load.	Tare Enter/clear a tare value. Clears the accumulation when the accumulation information is displayed.
Secondary Function (Long Press)	Off Turns the scale Off.	Units Changes the weighing unit.	Mode Allows changing the application mode.	Menu Enter the User menu.	
Menu Function (Short Press)	Yes Accepts the current setting on the display.	No Advances to the next menu or menu item. Rejects the current setting on the display and advances to the next available setting.	Back Moves Back to previous menu item.	Exit Exits the User menu. Aborts the calibration in progress.	

Notes: ¹ Short Press: Press less than 1 second.

² Long Press: Press and hold for more than 2 seconds.

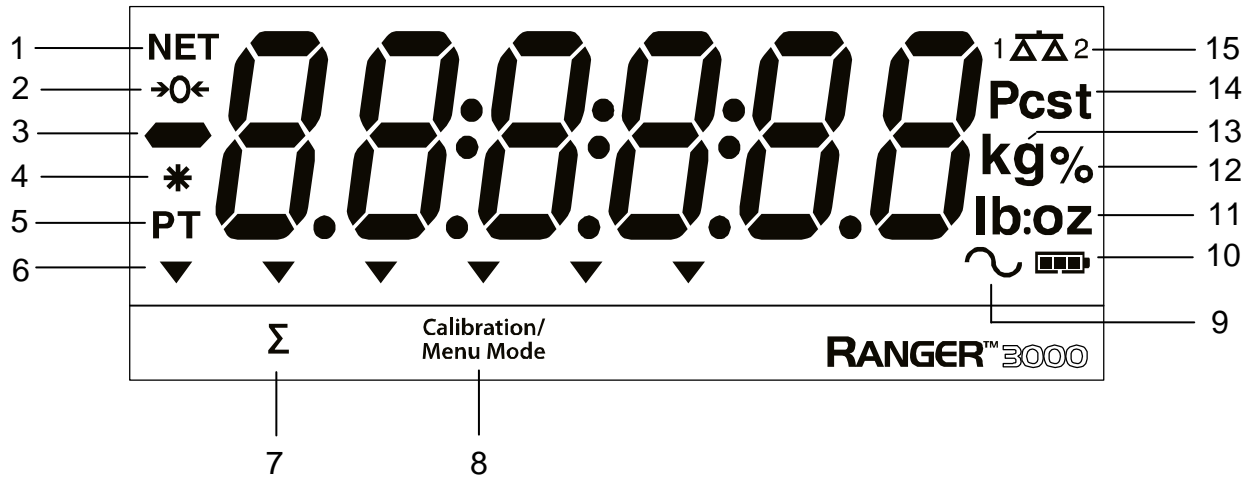

Figure 3-2. LCD Display

TABLE 3-2. LCD Symbols

Item	Description	Item	Description
1	NET symbol	9	Dynamic (tilde) symbol
2	Center of Zero symbol	10	Battery charge symbol
3	Negative symbol	11	Pound, Ounce, Pound:Ounce symbols
4	Stable weight symbol	12	Percent symbol
5	Preset Tare, Tare symbols	13	Kilogram, gram symbols
6	Pointer symbols	14	Pieces symbol, tonne symbol (not used)
7	Accumulation symbol	15	Scale symbol (not used)
8	Calibration / Menu Mode symbol		

The colored LED indicators on the left side of the control panel are used in Check mode (section 3.6) and will light up according to the following rules:

- ⬆ (Red) Loads > Upper limit
- (Green) Loads \geq Lower limit and \leq Upper limit
- ⬇ (Yellow) Loads < Lower limit

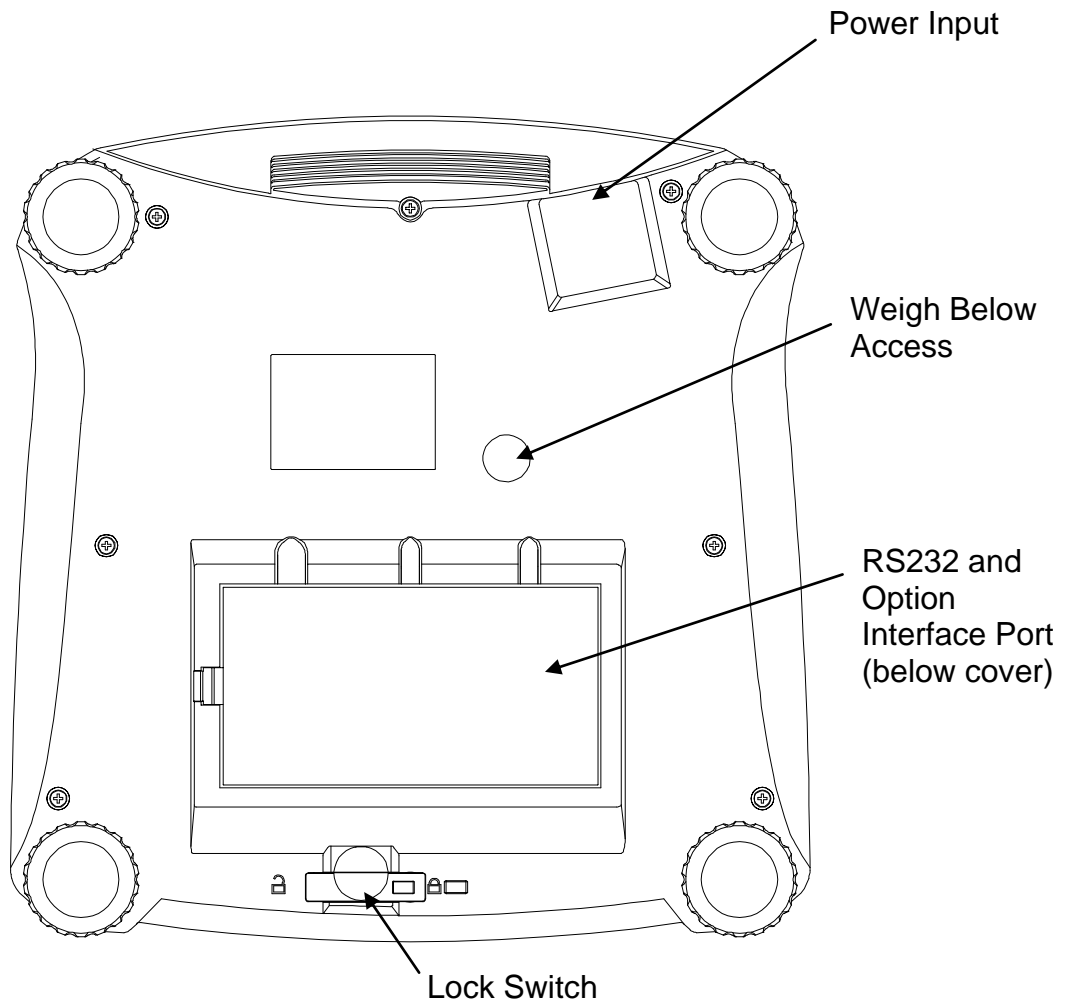

Figure 3-4. Below view of Ranger 3000

3.2 Turning Scale On/Off

To turn the scale on, press and hold the **On/Zero Off** button for 1 second. The scale performs a display test, momentarily displays the software version, and then enters the active weighing mode.

To turn the scale off, press and hold the **On/Zero Off** button until OFF is displayed.

3.3 Weigh Mode

This mode is the factory default setting.

1. If needed, press and hold **Mode** until [**WEIGH**] (Weigh) is displayed.
2. If required, place an empty container on the pan and press **Tare**.
3. Add sample to the pan or container. The display shows the weight of the sample.

3.4 Percent Mode

This mode measures the weight of a sample as a percentage of a reference weight.

1. If required place an empty container on the pan and press **Tare**.
2. Press and hold **Mode** until [**PERCENT**] is displayed. [**CLR.REF**] (clear reference) will then display. If no reference weight exists, the scale will display [**Pwt.REF**], proceed to step 5.
3. Press **No** to use the stored reference weight and proceed to step 6.
4. Press **Yes** to establish a new reference. Scale will now display [**Pwt.REF**].
5. Add the desired reference material to the pan or container. Press **Yes** to store the reference weight. The display shows 100%.
6. Replace the reference material with the sample material. The display shows the percentage of the sample compared to reference weight.
7. To clear the stored reference press and hold **Mode** until [**PERCENT**] is displayed. Press **Yes** when [**CLR.REF**] is displayed.

Note: Press **Function** to view the current reference weight.

3.5 Counting Mode

This mode counts large numbers of items based on the weight of a reference count.

1. Place an empty container on the pan and press **Tare**.
2. Press and hold **Mode** until [**COUNT**] (Count) is displayed. [**CLR.PW**] (Clear Average Piece Weight, APW) will then display.
If no APW exists, the scale will display [**Pwt. 10**], proceed to step 5.
3. Press **No** to use the stored APW. Proceed to step 7.
4. Press **Yes** to establish an APW.
5. The scale will then display the stored sample size, i.e. [**Pwt 10**]. Press **No** or **Back** to toggle the choices (5, 10, 20, 50 or 100).
6. Put the indicated number of pieces on the pan then press **Yes** to calculate the APW. The display shows the piece count.
7. Add additional pieces until the desired count is reached.
8. To clear the stored APW press and hold **Mode** until [**COUNT**] is displayed. Press **Yes** when [**CLR.PW**] is displayed.

Note: Press **Function** to view the current APW.

3.6 Check Mode

Use this mode to compare the Weight, Percent or Count of items to a target range. The scale supports positive, negative and zero check weighing.

Refer to section 4.5 to set the desired Check sub-mode.

3.6.1 Check Weighing

Set Checkweigh to Weight in the Mode menu. Use this mode to compare the weight of items to a target weight range.

1. Press and hold **Mode** until [**CHECK**] (Check) is displayed. [**CL.L OFF**] (clear check limits) will then display.
2. Press **No** to use the stored check limits and proceed to step 5.
3. Press **Yes** to establish new check limits. The scale will then display [**SEt. Lo**]. Press **Yes** to view the “Low” limit value. Press **Yes** to accept or **No** to edit the “Low” limit value. The stored value then displays with the first digit highlighted [**000.000** kg]. Repeatedly press **No** until the desired number appears. Press **Yes** to accept and highlight the next digit. Repeat until all the digits are correct. Press **Yes** to accept the “low” limit value, [**SEt. Hi**] will be displayed.
4. Repeat the same procedure to accept or edit the “high” value.
5. If required, place an empty container on the pan and press **Tare**.
6. Place sample material on the pan or in the container. If the sample weight is under the target weight range, the yellow LED will light.
If the sample is within the target weight range, the green LED will light. If the sample is over the target weight range, the red LED will light.

Note: Press **Function** to view the low and high check limits.

3.6.2 Check Percent

Set Checkweigh to Percent in the Mode menu. Use this mode to compare the percentage of items to a target percent range.

1. Press and hold **Mode** until [**CHECK**] (Check) is displayed. [**CL.r.r EF**] (clear reference) will then display. If no reference weight exists, the scale will display [**Pwt.r EF**], proceed to step 4.
2. Press **No** to use the stored reference weight and proceed to step 5.
3. Press **Yes** to establish a new reference. Scale will now display [**Pwt.r EF**].
4. Add the desired reference material to the pan or container. Press **Yes** to store the reference weight.
5. The scale will display [**CL.L OFF**] (clear Check limits).
6. Press **No** to use the stored check limits and proceed to step 9.
7. Press **Yes** to establish new check limits. The scale will then display [**SEt. Lo**]. Press **Yes** to view the “Low” limit value. Press **Yes** to accept or **No** to edit the “Low” limit value. The stored value then displays with the first digit highlighted [**000.000** %]. Repeatedly press **No** until the desired number appears. Press **Yes** to accept and highlight the next digit. Repeat until all the digits are correct. Press **Yes** to accept the “low” limit value, [**SEt. Hi**] will be displayed.
8. Repeat the same procedure to accept or edit the “high” value.
9. If required, place an empty container on the pan and press **Tare**.

- Place sample material on the pan or in the container. If the sample weight is under the target percentage range, the yellow LED will light. If the sample is within the target percentage range, the green LED will light. If the sample is over the target percentage range, the red LED will light.

Note: Press **Function** to view the low and high check limits.

3.6.3 Check Count

Set Checkweigh to Count in the Mode menu. Use this mode to compare the quantity of items to a target quantity range.

- Press and hold **Mode** until [**CHECK**] (Check) is displayed. [**CLR.PW**] (clear APW) will then display.
If no APW exists, the scale will display [**Pwt. 10**], proceed to step 5.
- Press **No** to use the stored APW and proceed to step 5.
- Press **Yes** to establish a new APW. Scale will now display [**Pwt. 10**]. Press **No** or **Back** to toggle the choices (5, 10, 20, 50 or 100).
- Put the indicated number of pieces on the pan then press **Yes** to calculate the APW.
- The scale will display [**CLL 100**] (clear Check limits).
- Press **No** to use the stored check limits and proceed to step 9.
- Press **Yes** to establish new check limits. The scale will then display [**SEt. Lo**]. Press **Yes** to view the “Low” limit value. Press **Yes** to accept or **No** to edit the “Low” limit value. The stored value then displays with the first digit highlighted [**000000** Pcs]. Repeatedly press **No** until the desired number appears. Press **Yes** to accept and highlight the next digit. Repeat until all the digits are correct. Press **Yes** to accept the “low” limit value, [**SEt. Hi**] will be displayed.
- Repeat the same procedure to accept or edit the “high” value.
- If required, place an empty container on the pan and press **Tare**.
- Place sample material on the pan or in the container. If the sample weight is under the target quantity range, the yellow LED will light. If the sample is within the target quantity range, the green LED will light. If the sample is over the target quantity range, the red LED will light.

Note: Press **Function** to view the low and high check limits.

Positive Check

Positive check is used to determine when the material added to the scale is within the target range. In this case the UNDER and OVER limits must be positive values. (The OVER limit must be greater than the UNDER limit.)

Add material to the scale until it is within the ACCEPT (green) range.

Negative Check

Negative check is used to determine when the material removed from the scale is within the target range. In this case the UNDER and OVER limits are both negative values.

The UNDER limit must be greater than the OVER limit (for example: UNDER = -10/OVER = -15).

Place the item to be weighed on the scale and press **TARE**.

Remove a portion of the item until it is within the ACCEPT range.

Zero Check

Zero check is used when comparing subsequent samples to an initial reference sample. In this case, the UNDER limit must be a negative value and the OVER limit must be a positive value. Place the reference item on the scale and press **TARE**. Remove the reference sample and place the item to be compared on the scale to determine if it is within the ACCEPT range.

3.7 Dynamic Mode

This mode allows the user to weigh an unstable load such as a moving animal. The weight is held on the display until reset. Manual, semi-automatic and automatic start/reset methods are available.

Manual operation (DYNAMIC is set to MANUAL in the Mode menu):

1. Press and hold **Mode** until [DYNAMIC] (Dynamic) is displayed. [READY] (Ready) will then be displayed.
2. Place the load on the pan and press the **Function** key to start measurement.
During the average period, the countdown timer decreases in one second increments.
3. After completed countdown, the average weight will be displayed. The tilde (dynamic) symbol will blink indicating that the current weight is being held.
4. Manually reset the countdown timer by pressing the **Function** key. [READY] (Ready) will then be displayed.

Note: If Set0 has been selected, the countdown timer is not displayed. The first stable weight larger than 5d will be displayed and held.

Semi-automatic operation (DYNAMIC is set to SEMI in the Mode menu):

1. Press and hold **Mode** until [DYNAMIC] (Dynamic) is displayed. [READY] (Ready) will then be displayed.
2. Place the load on the pan to start measurement.
During the average period, the countdown timer decreases in one second increments.
3. After completed countdown, the average weight will be displayed. The tilde (dynamic) symbol will blink indicating that the current weight is being held.
4. Manually reset the countdown timer by pressing the **Function** key. [READY] (Ready) will then be displayed.

Note: If Set0 has been selected, the countdown timer is not displayed. The first stable weight larger than 5d will be displayed and held.

Automatic operation (DYNAMIC is set to AUTOMATIC in the Mode menu):

1. Press and hold **Mode** until [DYNAMIC] (Dynamic) is displayed. [READY] (Ready) will then be displayed.
2. Place the load on the pan to start measurement.
During the average period, the countdown timer decreases in one second increments.
3. After completed countdown, the average weight will be displayed. The tilde (dynamic) symbol will blink indicating that the current weight is being held.
4. Remove the load and the display will reset after 10 seconds, [READY] (Ready) will then be displayed.

Notes: If Set0 has been selected, the countdown timer is not displayed. The first stable weight larger than 5d will be displayed and held.
Alternatively, the display may be manually reset by pressing the **Function** key.

3.8 Accumulation and Statistics

The Accumulation feature enables manual or automatic totalizing of displayed values. Statistical data (total accumulated weight, min/max weights, pieces, percent, and total number of weighments) is stored in memory for review and printing. Accumulation works together with each application mode except Dynamic.

3.8.1 Accumulating Displayed Values

With ACCUMULATE set to MANUAL, place the item on the scale and press the **M+** key to add the weight to accumulation data. The Σ pointer will keep flashing until the weight is removed and stable.

With ACCUMULATE set to AUTO, place the item on the scale. The displayed value is accumulated automatically. The Σ pointer will keep flashing until the weight is removed.

3.8.2 Viewing and Clearing Statistical Data

When the pan is cleared, press the **M+** key to display the statistical information. To clear the accumulation data press the **Tare** key while the statistical information is displayed. The display shows [CLR.ACC]. Press the **Yes** key to clear the stored data and return to current mode.

Notes: The item must be removed from the pan before the next item can be accumulated.

Only stable weights are stored to accumulation data.

Changing the mode will clear the accumulation data.

When Legal for Trade is ON, the display must return to 0 gross. Otherwise, the Σ pointer will continue flashing. Gross loads and net loads cannot be added to the same total. If the first load is a gross weight, future loads must also be gross weights. If the first load is a net weight, future loads must also be net weights.

Example:

In weighing mode; sub menu ACCUM setting, select MANUAL:
If required, place an empty container on the pan and press **Tare**.

Step i: Put the weight (0.04 kg) on the pan and press **M+** key. The Σ pointer indicator will keep flashing until the weight is removed.

Step ii: Remove the weight from the pan. Put another weight (0.03 kg) and press **M+** key:

Step iii: Remove the weight from the pan.

Step iv: Press **M+** key to display the statistical information:

Step v: If required, follow section 3.8.2 to clear the accumulation data.

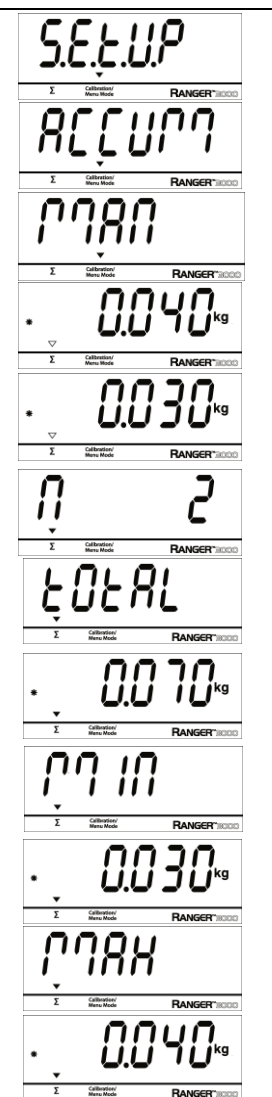

4. MENU SETTINGS

The User Menu allows the customizing of scale settings.

Note: Additional Sub-Menus may be available if Interface Options are installed. See Interface User Manual for the additional setting information.

4.1 Menu Navigation

User Menu:

Menu:	<i>C.A.L</i>	<i>S.E.t.U.P</i>	<i>r.E.A.d</i>	<i>M.O.d.E</i>	⇒
Menu Items:	Span Lin GEO End	Reset Pwr.Un Zero A.Tare Bp.Sig Bp.Key Accum End	Reset Stable Filter AZT Light A.Off End	Reset Weigh Percnt Count Check Dynam End	

⇒	<i>U.n.i.t</i>	<i>P.r.i.n.t.1</i>	<i>C.O.M.1</i>	<i>L.O.C.k</i>	<i>E.n.d</i>
Menu Items:	Reset kg g lb oz lb:oz End	Reset Stable A.Print Contnt Layout Data.Tr End	Reset Baud Parity Stop Handsh Alt.Cm End	L.Cal L.Setup L.Read L.Mode L.Unit L.Print L.COM End	

Notes:

Some modes/units may not be available in all models.

When LEGAL FOR TRADE is set to ON (Lock Switch in locked position), the menu settings are affected as follows:

Calibration (*C.A.L*) menu is not accessible.

Zero Range setting is locked at 2%.

Stable Range setting is locked at 1d.

Auto-Zero Tracking setting is locked at 0.5d.

Filter and Units are locked at their current settings.

Stable Only is locked On.

Auto Print/ Continuous is disabled.

Lb:oz is locked Off.

Summary of button navigation functions in menu mode:

- **Yes** Allows entry into the displayed menu.
 - Accepts the displayed setting and advances to the next item.
- **No** Skips by the displayed menu.
 - Rejects the displayed setting or menu item and advances to the next available item.
- **Back** Moves backwards through the upper and middle level menus.
 - Backs out of a list of selectable items to the previous middle level menu.
- **Exit** Exits from menu directly to the active weighing mode.

For menu items with numeric settings such as Capacity, the current setting is displayed with all digits flashing.
 Press the **No** button to begin editing.
 The first digit is displayed flashing.

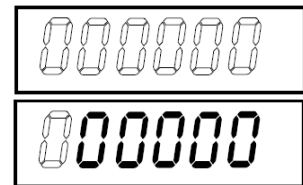

Press the **No** button to increment the digit or press the **Yes** button to accept the digit and move to the next digit.

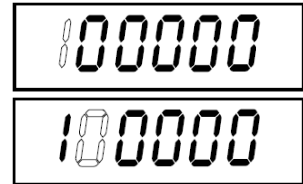

Repeat this process for all digits.

Press the **Yes** button when the last digit has been set.

The new setting is displayed with all digits flashing. Press the **Yes** button to accept the setting or press the **No** button to resume editing.

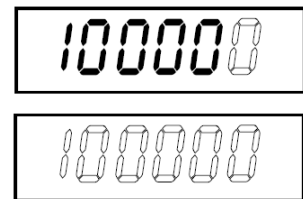

This method also applies to setting Checkweigh under and over targets.

For End menu items, pressing the **Yes** button advances to the next menu, while pressing the **No** button returns to the top of the current menu.

4.2 Calibration Menu

Enter this menu to perform calibrations.

Initial Calibration

When the scale is operated for the first time, a span calibration is recommended to ensure accurate weighing results. Before performing the calibration, be sure to have the appropriate calibration weights as listed in table 4-1. Ensure that the LFT switch/calibration lock is set to unlocked position. See figure 5-1.

Or adjust the GEO setting according to your location (see table 4-2).

Procedure:

Press and hold **Menu** until [MENU] (Menu) is displayed. When the button is released, the display will show [C.A.L.]. Press **Yes** to accept. [SPAN] will then be shown. Press **Yes** to begin the span calibration. [0 kg] will be displayed. Press **Yes** to accept. [- -C - -] will be displayed while zero reading is stored. Next, the display shows the calibration weight value. Place the specified calibration mass on the pan. Press **Yes** to accept the weight or **No** to select an alternate weight. [- -C - -] will be displayed while the reading is stored. The display will show [done] if the calibration was successful. The scale returns to the previous application mode and is ready for use.

TABLE 4-1

Required Span Calibration Mass (sold separately)			
Max	Mass*	Max	Mass*
1500g	1.5kg / 3lb	15000g	15kg / 30lb
3000g	3kg / 6lb	30000g	30kg / 60lb
6000g	6kg / 15lb		

Note: When active unit is g or kg, the calibrating unit will be in kg.
 When active unit is lb, oz or lb:oz, the calibrating unit will be in lb.
 For linearity calibration, the calibration Mass is fixed.
 Mid-point is always half of full capacity.

Span:	Perform
Linearity:	Perform
Geographic	
Adjustment:	Set 0... 12 ...31*
End Calibration:	Exit menu

***Bold** always represents factory default value.

Span [SPAN]

Initiates a span calibration procedure (zero and span)

Lin [L IN]

Initiates a linearity calibration procedure (zero, mid-point and span).

GEO [GEO]

Geographical Adjustment Factor (GEO) is used to adjust the calibration based on the current location. Settings from 0 to 31 are available with 12 being the default.

Refer to table 4-2 to determine the GEO factor that corresponds to your location.

End Cal [END]

Advance to the next menu or return to the top of the current menu.

4.3 Setup Menu

Enter this menu to set scale parameters. Default settings are in **bold**.

Reset:	no , yes
Power on unit:	auto , kg, g, lb, oz, lb:oz
Zero Range:	2%, 10%
Auto Tare:	off , on, on-acc
Beeper Signal:	off , accept, under, over, under-over
Beeper Key:	off , on
Accumulation:	off, auto, manual
End Setup:	Exit menu

Reset [RESET]

Reset the Setup menu to factory defaults.

NO = not reset

YES = reset

Power on unit [POWER.ON]

Set the unit of measure displayed at startup.

AUTO = last unit in use when turned off

kg = kilograms

g = grams

lb = pounds

oz = ounces

lb:oz = pound ounces

Zero Range [ZEr0]

Set the percentage of scale capacity that may be zeroed.

- 2% = zero up to 2 percent of capacity
- 10% = zero up to 10 percent of capacity

Auto Tare [A.tArE]

Set the automatic tare functionality.

- OFF = Automatic Tare is disabled
- ON = the first stable gross weight is tared
- ON-ACC = stable gross loads within the accept limits are tared (in Check weighing mode)

Beeper Signal [bP.5 iG]

Set how the beeper responds in Check Weighing mode.

- OFF = the beeper is disabled
- ACCEPT = the beeper will sound when the weight is within the Accept range.
- UNDER = the beeper will sound when the weight is below the Under setting.
- OVER = the beeper will sound when the weight is above the Over setting.
- OVER-UNDER = the beeper will sound when the weight is below the Under setting or above the Over setting.

Beeper Key [bP.tEy]

Set whether the beeper sounds when a button is pressed.

- OFF = no sound
- ON = sound

Accumulation [ACCUM]

Set the accumulation functionality.

- OFF = accumulation disabled
- AUTO = automatic accumulation
- MAN = manual accumulation

End Setup [End]

Advance to the next menu or return to the top of the current menu.

4.4 Readout Menu

Enter this menu to set user preferences. Default settings are in **bold**.

Reset:	no , yes
Stable Range:	0.5, 1 , 2, 5
Filter:	low, medium , high
Auto-Zero	
Tracking:	off, 0.5 , 1, 3
Light:	off, on, auto
Auto off:	off , 1, 5, 10
End Readout:	Exit menu

Reset [rESE]

Reset the Read menu to factory defaults.

- NO = not reset
- YES = reset

Stable Range [StABLE]

Set the amount the reading can vary while the stability symbol remains on.

- 0.5d = 0.5 scale division
- 1d = 1 scale division
- 2d = 2 scale division
- 5d = 5 scale division

Filter [FILT]

Set the amount of signal filtering.

- LOW = less stability, faster stabilization time
- MED = normal stability, stabilization time
- HI = greater stability, slower stabilization time

AZT [AZT]

Set the automatic zero tracking functionality.

- OFF = disabled
- 0.5d = the display will maintain zero until a change of 0.5 divisions per second has been exceeded.
- 1d = the display will maintain zero until a change of 1 divisions per second has been exceeded.
- 3d = the display will maintain zero until a change of 3 divisions per second has been exceeded.

Light [LIGH]

LCD models:

Sets backlight functionality.

- OFF = always off
- ON = always on
- AUTO = turns on when a button is pressed or the displayed weight changes.

Auto off [A.OFF]

Set the automatic shut off functionality.

- OFF = disabled
- 1 = powers off after 1 minute of no activity
- 5 = powers off after 5 minute of no activity
- 10 = powers off after 10 minute of no activity

End Readout [End]

Advance to the next menu or return to the top of the current menu.

4.5 Mode Menu

This menu activates modes so they will be available for use with the Mode button. Default settings are in **bold**.

Reset:	no , yes
Weigh:	off, on
Percent:	off, on
Count:	off, on
Check:	off , weigh, percnt, count
Dynamic:	off , man, semi, auto
End Mode:	Exit menu

Reset [RESEt]

Reset the Mode menu to factory defaults.

NO = not reset
YES = reset

Weigh [LWt WtH]

Set the status.

OFF = disabled
ON = enabled

Percent [PERCt]

Set the status.

OFF = disabled
ON = enabled

Count [COUNt]

Set the status.

OFF = disabled
ON = enabled

Check [CHECK]

Set the sub-mode

OFF = disabled
WEIGH = weight mode
PERCNT = percent mode
COUTN = count mode

Dynamic [dYNAmIC]

Set the status.

OFF = disabled
MAN = averaging and resetting are initiated manually
SEMI = averaging is automatically initiated
 resetting is manually initiated
AUTO = averaging and resetting are automatically initiated

End Mode [End]

Advance to the next menu or return to the top of the current menu.

4.6 Unit Menu

This menu activates units so they will be accessible with the **Units** button. The units in the menu must be turned “on” to be active.

Note: Available units vary by model and local regulations.

4.7 Print1 Menu

Enter this menu to set printing parameters. Default settings are **bold**.

Note: The Print2 menu is only displayed if a second interface is installed.

Reset:	no , yes
Stable Only:	off , on
Auto Print:	off on stable interval continuous accept
Content:	Result (-> off, on) Gross (-> off , on) Net (-> off , on) Tare (-> off , on) Header (-> off , on) Footer (-> off , on) Mode (-> off , on) Unit (-> off, on) Info (-> off , on) Accu (-> off , result, all)
Layout:	Format (-> S ,M) Feed (-> Line , 4 Lines, form)
Data Transfer:	off , on
End Print:	Exit menu

Reset [**rESEt**]

Reset the Print menu to factory defaults.

NO = no reset
YES = reset

Stable Only [**StABLE**]

Set the printing criteria.

OFF = values are printed immediately
ON = values are only printed when the stability criteria are met

Auto Print [A.Pr int]

Set the automatic printing functionality.

OFF	= disabled
ON.STAB	= printing occurs each time the stability criteria are met ¹
INTER	= printing occurs at the defined interval ²
CONT	= printing occurs continuously
ACCEPT	= printing occurs each time the display is within the Checkweigh accept range and stability criteria are met.

¹ When ON.STAB is selected, set the condition for printing, where:

LOAD	= printing occurs when the load is stable and greater than zero
LOAD.ZR	= printing occurs when any load is stable and equal to or greater than zero.

² When INTER is selected, set the Print Interval.

1 to 3600 (seconds)

Content [CONTNT]

Define the content of the printed data. See section 7.4 for sample printouts.

Result

Set the status.

OFF	= disabled
ON	= the displayed reading is printed

Gross

Set the status.

OFF	= disabled
ON	= the gross weight is printed

Net

Set the status.

OFF	= disabled
ON	= the net weight is printed

Tare

Set the status.

OFF	= disabled
ON	= the Tare weight is printed

Header

Set the status.

OFF	= disabled
ON	= the Header is printed

Note: See section 7.3.1 for how to enter Header line

Footer

Set the status.

OFF	= disabled
ON	= the Footer is printed

Note: See section 7.3.1 for how to enter Footer line

Mode

Set the status.

- OFF = disabled
- ON = the Mode is printed

Unit

Set the status.

- OFF = disabled
- ON = the Unit is printed

Info

Set the status.

- OFF = disabled
- ON = the reference information is printed (ex. APW or Checklimits)

Accu

Set the status.

- OFF = disabled
- RESULT = the Accumulation result is printed
- ALL = all the Accumulation data is printed

Layout [LAYOUT]

Set the format of the data output to a printer or computer.

Format

Set the printing format.

- MULTI = a multi-line (single column style) printout is generated.
- SINGLE = a single line printout is generated.

Feed

Set the paper feed.

- LINE = move a paper up one line after printing
- 4LF = move a paper up four lines after printing
- FORM = a form feed is appended to the printout

Data Transfer [DATA.TF]

Output weighing results directly to a PC application.

- OFF = disabled
- ON = enabled

Notes:

Data Transfer Function is not supported in Windows® 7/8. OHAUS provides SPDC software for Windows 7/8 users.

If the weighing value is a negative number, set the target cell in TEXT format. Otherwise, Excel will not distinguish it as a negative number.

Please do not use this function during continuous printing.

End Print [E_{nd}]

Advance to the next menu or return to the top of the current menu.

4.8 COM1 Menu

Enter this menu to define communication parameters.

Reset:	no , yes
Baud Rate:	300... 9600 ...19200
Parity:	7 even, 7 odd, 7 none, 8 none
Stop bit:	1 , 2
Handshake:	none , On-Off
Alternate command:	Print (A... P ...Z), Tare (A... T ...Z), Zero (A... Z)
End COM:	Exit menu

Note: The COM2 menu is only displayed if a second interface is installed.

Reset [rESEt]

Reset the COM menu to factory defaults.

NO = no reset
YES = reset

Baud Rate [bAUD]

Set the baud rate.

300 = 300 bps
600 = 600 bps
1200 = 1200 bps
2400 = 2400 bps
4800 = 4800 bps
9600 = 9600 bps
19200 = 19200 bps

Parity [PARiTY]

Set the data bits and parity.

7 EVEN = 7 data bits, even parity
7 ODD = 7 data bits, odd parity
7 NONE = 7 data bits, no parity
8 NONE = 8 data bits, no parity

Stop bit [StOP]

Set the number of stop bits.

1 = 1 stop bits
2 = 2 stop bits

Handshake [H.SHAkE]

Set the flow control method. Hardware handshaking is only available for COM1 menu.

NONE = no handshaking
ON-OFF = XON/XOFF software handshaking

Alternate command [ALt.[P]]

Define command character for the Print, Tare and Zero commands

Print

Set the alternate command character for Print
A to Z.

Tare

Set the alternate command character for Tare
A to Z.

Zero

Set the alternate command character for Zero.
A to Z.

End COM1, End COM2 [End]

Advance to the next menu or return to the top of the current menu.

4.9 Lock Menu

The Lock menu is a software controlled option which can lock menu settings to prevent tampering.

Reset:	no , yes
Lock Cal:	off , on
Lock Setup:	off , on
Lock Read:	off , on
Lock Mode:	off , on
Lock Unit:	off , on
Lock Print:	off , on
Lock COM:	off , on
End Menu Lock:	Exit menu

Reset [rESEt]

Reset the Lock menu to factory defaults.

NO = no reset
YES = reset

Lock Cal [L.[AL]

Set the status.

OFF = Calibration menu is not locked
ON = Calibration menu is locked

Lock Setup [L.[SEtUP]

Set the status.

OFF = Setup menu is not locked
ON = Setup menu is locked

Lock Read [L.[rERd]

Set the status.

OFF = Readout menu is not locked
ON = Readout menu is locked

Lock Mode [L.Mode]

Set the status.

- OFF = Mode menu is not locked
- ON = Mode menu is locked

Lock Unit [L.Unit]

Set the status.

- OFF = Unit menu is not locked
- ON = Unit menu is locked

Lock Print [L.Print]

Set the status.

- OFF = Print menu is not locked
- ON = Print menu is locked

Lock COM [L.COM]

Set the status.

- OFF = COM menu is not locked
- ON = COM menu is locked

End Lock [End] – Advance to the next menu or return to the top of the current menu.

4.10 End Menu

Press 'No' to advance to the Calibration menu. Press 'Yes' to exit the menu and return to the current application mode.

4.11 Additional Features

The Weigh Below Hook is provided with the scale. To use this feature, remove power from the scale and remove the protective cover for the weigh below opening. Install the hook into the access hole at the bottom of the scale as shown. Do not over tighten, tighten finger tight. Mount the scale onto an appropriate assembly that allows free working space below the hook. See figure 4-1.

Note: Never allow the scale to rest directly on the hook.

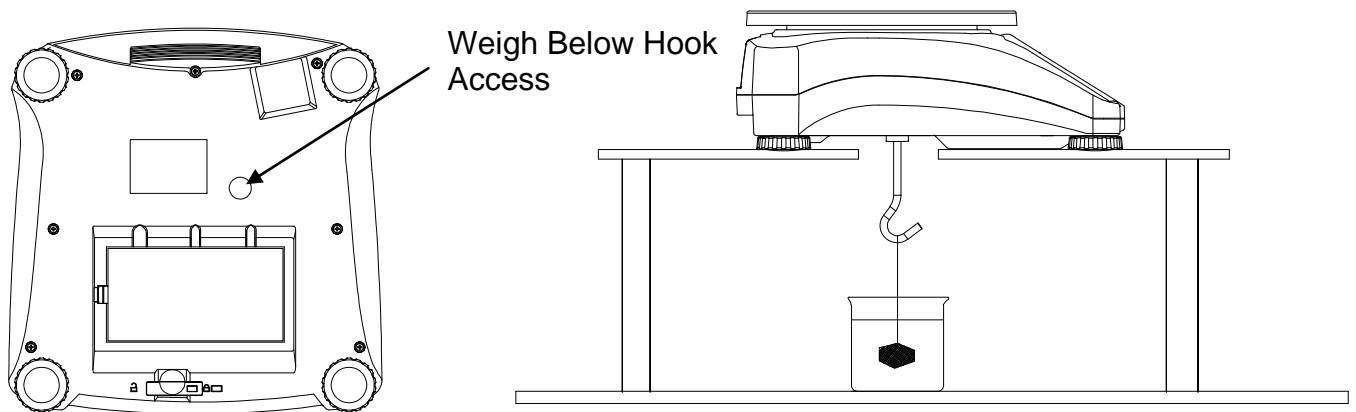

Figure 4-1. Setup for the Weigh Below Hook

TABLE 4-2. GEO CODES

		Elevation in meters										
		0	325	650	975	1300	1625	1950	2275	2600	2925	3250
		325	650	975	1300	1625	1950	2275	2600	2925	3250	3575
		Elevation in feet										
Latitude		0	1060	2130	3200	4260	5330	6400	7460	8530	9600	10660
		1060	2130	3200	4260	5330	6400	7460	8530	9600	10660	11730
		GEO value										
0°00'	5°46'	5	4	4	3	3	2	2	1	1	0	0
5°46'	9°52'	5	5	4	4	3	3	2	2	1	1	0
9°52'	12°44'	6	5	5	4	4	3	3	2	2	1	1
12°44'	15°06'	6	6	5	5	4	4	3	3	2	2	1
15°06'	17°10'	7	6	6	5	5	4	4	3	3	2	2
17°10'	19°02'	7	7	6	6	5	5	4	4	3	3	2
19°02'	20°45'	8	7	7	6	6	5	5	4	4	3	3
20°45'	22°22'	8	8	7	7	6	6	5	5	4	4	3
22°22'	23°54'	9	8	8	7	7	6	6	5	5	4	4
23°54'	25°21'	9	9	8	8	7	7	6	6	5	5	4
25°21'	26°45'	10	9	9	8	8	7	7	6	6	5	5
26°45'	28°06'	10	10	9	9	8	8	7	7	6	6	5
28°06'	29°25'	11	10	10	9	9	8	8	7	7	6	6
29°25'	30°41'	11	11	10	10	9	9	8	8	7	7	6
30°41'	31°56'	12	11	11	10	10	9	9	8	8	7	7
31°56'	33°09'	12	12	11	11	10	10	9	9	8	8	7
33°09'	34°21'	13	12	12	11	11	10	10	9	9	8	8
34°21'	35°31'	13	13	12	12	11	11	10	10	9	9	8
35°31'	36°41'	14	13	13	12	12	11	11	10	10	9	9
36°41'	37°50'	14	14	13	13	12	12	11	11	10	10	9
37°50'	38°58'	15	14	14	13	13	12	12	11	11	10	10
38°58'	40°05'	15	15	14	14	13	13	12	12	11	11	10
40°05'	41°12'	16	15	15	14	14	13	13	12	12	11	11
41°12'	42°19'	16	16	15	15	14	14	13	13	12	12	11
42°19'	43°26'	17	16	16	15	15	14	14	13	13	12	12
43°26'	44°32'	17	17	16	16	15	15	14	14	13	13	12
44°32'	45°38'	18	17	17	16	16	15	15	14	14	13	13
45°38'	46°45'	18	18	17	17	16	16	15	15	14	14	13
46°45'	47°51'	19	18	18	17	17	16	16	15	15	14	14
47°51'	48°58'	19	19	18	18	17	17	16	16	15	15	14
48°58'	50°06'	20	19	19	18	18	17	17	16	16	15	15
50°06'	51°13'	20	20	19	19	18	18	17	17	16	16	15
51°13'	52°22'	21	20	20	19	19	18	18	17	17	16	16
52°22'	53°31'	21	21	20	20	19	19	18	18	17	17	16
53°31'	54°41'	22	21	21	20	20	19	19	18	18	17	17
54°41'	55°52'	22	22	21	21	20	20	19	19	18	18	17
55°52'	57°04'	23	22	22	21	21	20	20	19	19	18	18
57°04'	58°17'	23	23	22	22	21	21	20	20	19	19	18
58°17'	59°32'	24	23	23	22	22	21	21	20	20	19	19
59°32'	60°49'	24	24	23	23	22	22	21	21	20	20	19
60°49'	62°90'	25	24	24	23	23	22	22	21	21	20	20
62°90'	63°30'	25	25	24	24	23	23	22	22	21	21	20
63°30'	64°55'	26	25	25	24	24	23	23	22	22	21	21
64°55'	66°24'	26	26	25	25	24	24	23	23	22	22	21
66°24'	67°57'	27	26	26	25	25	24	24	23	23	22	22
67°57'	69°35'	27	27	26	26	25	25	24	24	23	23	22
69°35'	71°21'	28	27	27	26	26	25	25	24	24	23	23
71°21'	73°16'	28	28	27	27	26	26	25	25	24	24	23
73°16'	75°24'	29	28	28	27	27	26	26	25	25	24	24
75°24'	77°52'	29	29	28	28	27	27	26	26	25	25	24
77°52'	80°56'	30	29	29	28	28	27	27	26	26	25	25
80°56'	85°45'	30	30	29	29	28	28	27	27	26	26	25
85°45'	90°00'	31	30	30	29	29	28	28	27	27	26	26

5. LEGAL FOR TRADE

When the scale is used in trade or a legally controlled application it must be set up, verified and sealed in accordance with local weights and measures regulations. It is the responsibility of the purchaser to ensure that all pertinent legal requirements are met.

5.1 Capacity Label

A label showing the capacity and readability of the scale must be installed near each display. If the Capacity Labels were installed prior to delivery, no further action is needed. If the Capacity Labels were not installed, they have been placed in the packaging material. Affix the labels above the displays as shown in Figure 5-1.

Note: The Capacity Labels will be destroyed upon removal, so only attempt to install them once.

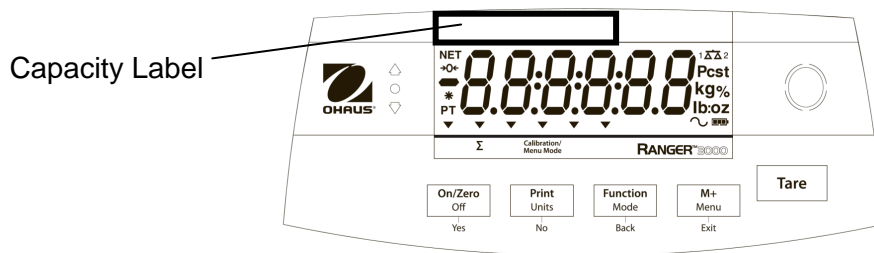

Figure 5-1. Capacity Label location

5.2 Settings

Before verification and sealing, perform the following steps:

1. Verify that the menu settings meet the local weights and measures regulations.
2. Perform a calibration, see section 4.2.
3. Set the switch to Locked. See figure 5-2.

The Menu Lock switch limits changes to the Cal, Setup, Readout, Unit and Print menus. The switch in type approved models may set some scale settings as required by the approval agency. The switch may be secured using paper seals, wire seals or plastic ties.

Note: When LEGAL FOR TRADE is set to ON (LFT Switch in locked position), the menu settings are affected as follows:

- Calibration (C.A.L) menu is not accessible
- Zero Range setting is locked at 2%.
- Stable Range setting is locked at 1d
- Auto-Zero Tracking setting is locked at 0.5d
- Filter and Units are locked at their current settings
- Stable Only is locked On
- Auto Print/ Continuous is disabled
- lb:oz is locked Off.

5.3 Verification and Sealing

The local weights and measures official or authorized service agent must perform the verification procedure.

5.3.1 Physical Seals

For jurisdictions that use the physical sealing method, the local weights and measures official or authorized service agent must apply a security seal to prevent tampering with the settings. Refer to the illustration below for sealing methods.

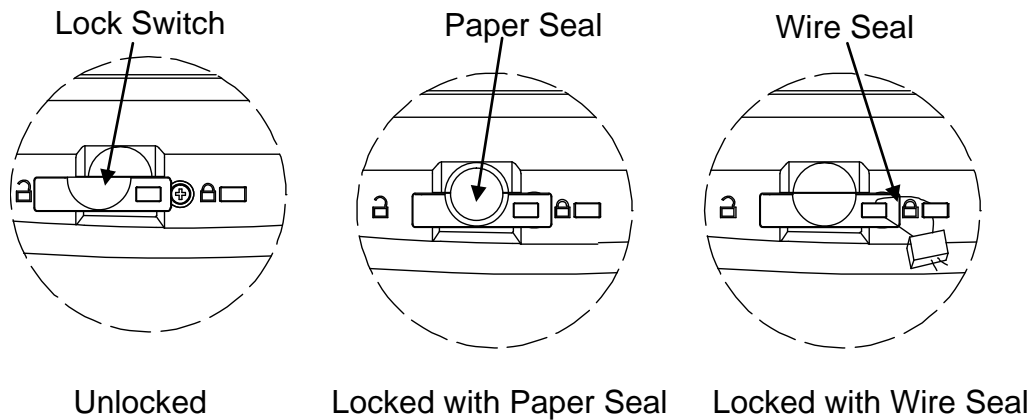

Figure 5-2. Sealing

5.3.2 Audit Trail Seal (USA and Canada only)

For jurisdictions that use the audit trail sealing method, the local weights and measures official or authorized service agent must record the current configuration and calibration event counter values at the time of sealing. These values will be compared to values found during a future inspection.

Note: A change to an event counter value is equivalent to breaking a physical seal.

The audit trail uses two event counters to record changes to configuration and calibration settings.

- The configuration event counter (CFG) will index by 1 when exiting the menu if one or more of the following menu settings are changed: Zero Range, Stable Range, Auto Zero Tracking (AZT), Units (kg, g, oz, lb or lb:oz) or Stable Only.
- The calibration event counter (CAL) will index by 1 when exiting the menu if a Span Calibration or GEO setting change is made. Note that the counter only indexes once, even if several settings are changed.

The event counters can be viewed by pressing and holding the MENU button.

While the button is held, the display will show MENU followed by Audit.



Release the button when Audit is displayed to view the audit trail information.



The audit trail information is displayed in the format CFGxxx and CALxxx.



The scale then returns to normal operation



6. MAINTENANCE

6.1 Cleaning

The housing may be cleaned with a cloth dampened with a mild detergent if necessary. Do not use solvents, chemicals, alcohol, ammonia or abrasives to clean the housing or control panel.

6.2 Troubleshooting

The following table lists common problems and possible causes and remedies.

If the problem persists, contact OHAUS or your authorized dealer.

TABLE 6-1

Symptom	Possible Cause	Remedy
Cannot turn on	No power to scale	Verify connections and voltage
Poor accuracy	Improper calibration Unstable environment	Perform calibration Move scale to suitable location
Cannot calibrate	LFT locked	See chapter 5 for information
Cannot access mode	Mode not enabled	Enter menu and enable mode
Cannot access unit	Unit not enabled	Enter menu and enable unit
Battery icon flashing	Low Battery error	Connect scale to AC power and charge the battery
Err 8.1	Power On Error	Weight reading exceeds Power On Zero limit
Err 8.2	Power On Error	Weight reading below Power On Zero limit.
Err 8.3	Over Range Error	Weight reading exceeds Overload limit
Err 8.4	Under Range Error	Weight reading below Underload limit
Err 8.5	Tare out of range	Adjust tare value to be within range
Err 8.6	Display overflow	Weight exceeds 6 digits
Err 9.5	Calibration data error	Calibration data not present
-----	Busy	Displayed during tare setting, zero setting, printing
-- NO --	Action not allowed	Function not executed
CAL E	Calibration error Unstable environment Incorrect calibration weight	Calibration value outside allowed limits Move the scale to suitable location Use correct calibration weight
Lo.rEF	Low reference weight warning	Increase reference weight
rEF.Err	Unacceptable reference weight	Reference weight too small. Weight on the pan is too small to define a valid reference weight. Increase reference weight.
NO.ACC	Gross and net weights cannot be accumulated together	Only accumulate gross or net weights (only works in LFT)
Battery fails to charge fully	Battery is defective	Have battery replaced by Ohaus authorized service dealer.

6.3 Service Information

If the troubleshooting section does not resolve or describe your problem, contact your authorized OHAUS service agent. For service assistance or technical support in the United States call toll-free 1-800-526-0659 between 8:00 AM and 5:00 PM EST. An OHAUS product service specialist will be available to provide assistance. Outside the USA, please visit our web site, www.ohaus.com to locate the OHAUS office nearest you.

6.4 Accessories

TABLE 6-2. ACCESSORIES

DESCRIPTION	PART NUMBER
Ethernet Interface Kit	30037447
2 nd RS232 Interface Kit	30037448
USB Interface Kit	30037449
In Use Cover	30037451
Weighing Below Hook	30037450
Printer	Contact Ohaus
Communication Cables	Contact Ohaus

7. TECHNICAL DATA

The technical data is valid under the following ambient conditions:

Indoor use only

Operating temperature: -10°C to 40°C

Relative humidity: 20% to 85% relative humidity, non-condensing

Altitude: Up to 2000 m

Power: AC power 100-240V 50/60 Hz, internal rechargeable sealed lead acid battery

Current rating: 0.5A

Mains supply voltage fluctuations: up to $\pm 10\%$ of the nominal voltage

Installation category: II

Pollution degree: 2

7.1 Specifications

TABLE 7-1. SPECIFICATIONS

MODEL	R31P1502	R31P3	R31P6	R31P15	R31P30
Capacity x Readability (Max x d non-approved)	1.5 kg x 0.00005 kg 1500 g x 0.05 g 3 lb x 0.0001 lb 48 oz x 0.002 oz	3 kg x 0.0001 kg 3000 g x 0.1 g 6 lb x 0.0002 lb 96 oz x 0.005 oz	6 kg x 0.0002 kg 6000 g x 0.2 g 15 lb x 0.0005 lb 240 oz x 0.01 oz	15 kg x 0.0005 kg 15000 g x 0.5 g 30 lb x 0.001 lb 480 oz x 0.02 oz	30 kg x 0.001 kg 30000 g x 1 g 60 lb x 0.002 lb 960 oz x 0.05 oz
Maximum Displayed Resolution	1:30000				
Capacity x Readability (Max x e approved)	1.5 kg x 0.0005 kg 1500 g x 0.5 g 3 lb x 0.001 lb 48 oz x 0.02 oz	3 kg x 0.001 kg 3000 g x 1 g 6 lb x 0.002 lb 96 oz x 0.05 oz	6 kg x 0.002 kg 6000 g x 2 g 15 lb x 0.005 lb 240 oz x 0.1 oz	15 kg x 0.005 kg 15000 g x 5 g 30 lb x 0.01 lb 480 oz x 0.2 oz	30 kg x 0.01 kg 30000 g x 10 g 60 lb x 0.02 lb 960 oz x 0.5 oz
Approved Resolution	1:3000				
Repeatability	± 0.0001 kg	± 0.0002 kg	± 0.0005 kg	± 0.001 kg	± 0.002 kg
Linearity	± 0.0001 kg	± 0.0002 kg	± 0.0005 kg	± 0.001 kg	± 0.002 kg
Weighing Units	LFT OFF: g, kg, lb, oz, lb:oz LFT ON: g, kg, lb, oz EC and OIML Approved models: g, kg				
Tare Range	To capacity by subtraction				
Stabilization Time	≤ 1 second				
Safe Overload Capacity	150 % of capacity				
Weight Display LCD	LCD with white LED backlight 6-digit 7-segment, 28 mm / 1.1 inches digit height				
Keyboard	5 mechanical buttons				
Application Modes	Weighing, Dynamic Weighing / Display Hold, Counting, Check Weigh, Check Counting, Check Percent, Percent Weighing, Accumulation				
Battery Operating Time (at 20°C)	210 hours for LCD version with backlight turned off				
Construction	ABS plastic housing with 304 stainless steel platform				
Approval Class	III				
Pan Dimensions	225 x 300 mm / 8.9 x 11.8 in				
Shipping Dimensions	397 x 447 x 195 mm / 15.6 x 17.6 x 7.7 in				
Net Weight	4.2 kg / 9.3 lb				
Gross Weight	5.45 kg / 12 lb				

7.2 Drawings

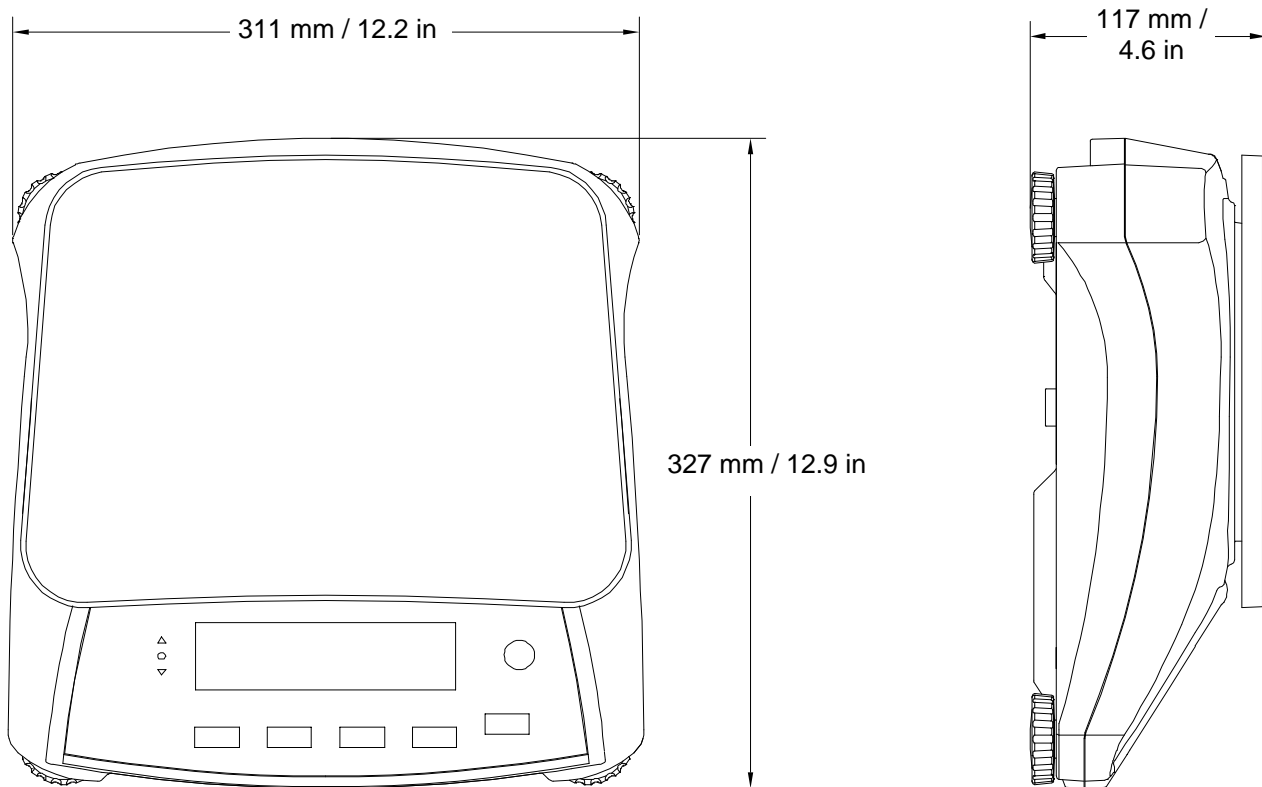

Figure 7-1. Dimensions

7.3 Communication

The scale is equipped with an RS232 interface (COM1) located under the Options Cover. Connecting the scale to a computer enables you to operate the scale from the computer, as well as receive data such as displayed weight.

7.3.1 Interface Commands

Communicate to the scale using the command characters listed in Table 7-2.

TABLE 7-2

Command	Function
IP	Immediate Print of displayed weight (stable or unstable).
P	Print displayed weight (stable or unstable).
CP	Continuous Print.
SP	Print on Stability.
xS	0S: Turn off "Stable Only" menu item and allow unstable print. 1S: Turn on "Stable Only" menu item and only print stable print.
xP	Interval Print x = Print Interval (1-3600 sec), 0P turns auto print OFF.
Z	Same as pressing Zero Key.
T	Same as pressing Tare Key.
xT	Download Tare value in grams (positive values only). Sending 0T clears tare (if allowed).
PU	Print current unit: g, kg, lb, oz, lb:oz
xU	Set scale to unit x: 1=g, 2=kg, 3=lb, 4=oz, 5=lb:oz
xM	Set scale to mode x. Sending only M will scroll to next enabled mode.
PV	Version: print name, software revision and LFT ON (if LFT is set ON).
H x "text"	Enter Header line, where x = line number 1 to 5, "text" = header text up to 24 alphanumeric characters.
F x "text"	Enter Footer line, where x = line number 1 to 2, "text" = rear text up to 24 alphanumeric characters.
\EscR	Global reset to reset all menu settings to the original factory defaults (Escape key + 'R' Key).

7.3.2 Connections for RS232

The 9-pin female subminiature "D" connector COM1, is provided for interfacing to other devices. The pin connections are as follows:

Active pins: PIN 2 = TXD, PIN 3 = RXD, PIN 5 = Ground

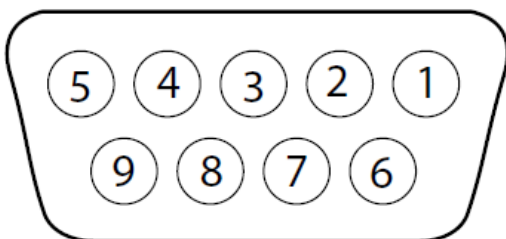

Figure 7-2. RS232 Pins

7.4 Printouts

The following sample print outs are generated by the **Print** button, “P” Command or alternate print command. The content of the printout is defined in the Print Content menu item.

Weigh Mode Printout

	Description	Comment
12.34 kg	Result line	If Printx → Content → Result is ON
12.34 kg G	Gross value line	If Printx → Content → Gross is ON and a tare value is entered
11.11 kg N	Net value line	If Printx → Content → Net is ON and a tare value is entered
1.23 kg T	Tare value line	If Printx → Content → Tare is ON and a tare value is entered
MODE: WEIGH	Mode line	If Printx → Content → Application Mode is ON
<no line printed>	Information line	If Printx → Content → Into is ON

Weigh Mode with Accumulation Printout

	Description	Comment
12.34 kg	Result line	If Printx → Content → Result is ON
12.34 kg G	Gross value line	If Printx → Content → Gross is ON and a tare value is entered
11.11 kg N	Net value line	If Printx → Content → Net is ON and a tare value is entered
1.23 kg T	Tare value line	If Printx → Content → Tare is ON and a tare value is entered
MODE: WEIGH	Mode line	If Printx → Content → Application Mode is ON
N: 4	Accumulation line	If Printx → Content → Accu is All
TOTAL: 50.35 kg	Accumulation line	If Printx → Content → Accu is All
MIN: 11.11 kg	Accumulation line	If Printx → Content → Accu is All
MAX: 14.85 kg	Accumulation line	If Printx → Content → Accu is All

Percent Mode Printout

	Description	Comment
102.83 %	Result line	If Printx → Content → Result is ON
12.34 kg G	Gross value line	If Printx → Content → Gross is ON and a tare value is entered
11.11 kg N	Net value line	If Printx → Content → Net is ON and a tare value is entered
1.23 kg T	Tare value line	If Printx → Content → Tare is ON and a tare value is entered
MODE: PERCNT	Mode line	If Printx → Content → Application Mode is ON
REF WGT: 12 kg	Information line	If Printx → Content → Info is ON

Count Mode Printout

	Description	Comment
2222 PCS N	Result line	If Printx → Content → Result is ON
12.34 kg G	Gross value line	If Printx → Content → Gross is ON and a tare value is entered
11.11 kg N	Net value line	If Printx → Content → Net is ON and a tare value is entered
1.23 kg T	Tare value line	If Printx → Content → Tare is ON and a tare value is entered
MODE: COUNT	Mode line	If Printx → Content → Application Mode is ON
APW: 5 g	Information line	If Printx → Content → Info is ON

Check (Weigh) Mode Printout

	Description	Comment
12.34 kg OVER	Result line	If Printx → Content → Result is ON, UNDER/ACCEPT/OVER
12.34 kg G	Gross value line	If Printx → Content → Gross is ON and a tare value is entered
11.11 kg N	Net value line	If Printx → Content → Net is ON and a tare value is entered
1.23 kg T	Tare value line	If Printx → Content → Tare is ON and a tare value is entered
MODE: CHECKWEIGH	Mode line	If Printx → Content → Application Mode is ON
UNDER TARGET 1.00 kg	Information line	If Printx → Content → Info is ON
OVER TARGET 2.00 kg	Information line	If Printx → Content → Info is ON

Dynamic Mode Printout

	Description	Comment
12.34 kg	Result line	If Printx → Content → Result is ON
12.34 kg G	Gross value line	If Printx → Content → Gross is ON and a tare value is entered
11.11 kg N	Net value line	If Printx → Content → Net is ON and a tare value is entered
1.23 kg T	Tare value line	If Printx → Content → Tare is ON and a tare value is entered
MODE: DYNAMIC	Mode line	If Printx → Content → Application Mode is ON
LEVEL 10	Information line	If Printx → Content → Info is ON

7.5 Output Format

The printout string has a fixed length of 22 characters for most applications except check weighing. For check weighing mode, the printout string has a fixed length of 29 characters.

Weight string print format:

Check Weighing application:

Field	Weight (Right aligned)	Space	Unit (Right aligned)	Space	Stability (?)	Space	T/N/G/PT (Right aligned)	Space	Application Status (Right aligned)	Term.
Length	11	1	5	1	1	1	2	1	6	2

Non-Check Weighing application:

Field	Weight (Right aligned)	Space	Unit (Right aligned)	Space	Stability (?)	Space	T/N/G/PT (Right aligned)	Term.
Length	11	1	5	1	1	1	2	2

Each field is followed by a single delimiting space (ASCII: 32).

Definitions:

Weight - Up to 11 characters, right justified, - at immediate left of most significant character (if negative).

Unit - Up to 5 characters, right justified. If the Unit in the Print Content menu was set to OFF, the unit will be removed in the weight string and replaced by spaces.

Stability - “?” character is printed if not stable. If weight is stable a space is printed.



T/N/G/PT - “T” is printed for a tare weight, “NET” printed if weight is net weight, ‘G’ or nothing printed if weight is a gross weight, ‘PT’ is printed if the tare weight is Pre-set Tare.

Application Status (for Check) – Fixed to 6 characters. Display status like "Under", "Accept" and "Over" for check weighing.



Terminating Character(s) - terminating character(s) printed depending on FEED menu setting.



7.6 Compliance

Compliance to the following standards is indicated by the corresponding mark on the product.

Mark	Standard
	This product conforms to the EMC Directive 2004/108/EC, the Low Voltage Directive 2006/95/EC and the Non-Automatic Weighing Instrument Directive 2009/23/EC. The Declaration of Conformity is available online at europe.ohaus.com/europe/en/home/support/compliance.aspx .
	AS/NZS CISPR 11
	CAN/CSA-C22.2 No. 61010-1-12, UL Std. No. 61010-1

Important notice for verified weighing instruments

  Weighing Instruments verified at the place of manufacture bear one of the preceding marks on the packing label and the green 'M' (metrology) sticker on the descriptive data plate. They may be put into service immediately.

  Weighing Instruments to be verified in two stages have no green 'M' (metrology) on the descriptive data plate and bear one of the preceding identification marks on the packing label. The second stage of the initial verification must be carried out by an authorized and certified service organization established within the European Community or by the National Notified Body.

The first stage of the initial verification has been carried out at the manufacturers work. It comprises all tests according to the adopted European standard EN 45501:1992, paragraph 8.2.2.

If national regulations limit the validity period of the verification, the user of the weighing instrument must strictly observe the re-verification period and inform the respective weights and measures authorities.

Disposal

In conformance with the European Directive 2002/96/EC on Waste Electrical and Electronic Equipment (WEEE) this device may not be disposed of in domestic waste. This also applies to countries outside the EU, per their specific requirements.

The Batteries Directive 2006/66/EC introduces new requirements from September 2008 on removability of batteries from waste equipment in EU Member States. To comply with this Directive, this device has been designed for safe removal of the batteries at end-of-life by a waste treatment facility.

Please dispose of this product in accordance with local regulations at the collecting point specified for electrical and electronic equipment. If you have any questions, please contact the responsible authority or the distributor from which you purchased this device.

Should this device be passed on to other parties (for private or professional use), the content of this regulation must also be related.

Disposal instructions in Europe are available online at europe.ohaus.com/europe/en/home/support/weee.aspx.

Thank you for your contribution to environmental protection.

FCC Note

This equipment has been tested and found to comply with the limits for a Class B digital device, pursuant to Part 15 of the FCC Rules. These limits are designed to provide reasonable protection against harmful interference when the equipment is operated in a commercial environment. This equipment generates, uses, and can radiate radio frequency energy and, if not installed and used in accordance with the instruction manual, may cause harmful interference to radio communications. Operation of this equipment in a residential area is likely to cause harmful interference in which case the user will be required to correct the interference at his own expense.

Industry Canada Note

This Class B digital apparatus complies with Canadian ICES-003.

ISO 9001 Registration

In 1994, OHAUS Corporation, USA, was awarded a certificate of registration to ISO 9001 by Bureau Veritas Quality International (BVQI), confirming that the OHAUS quality management system is compliant with the ISO 9001 standard's requirements. On June 21, 2012, OHAUS Corporation, USA, was re-registered to the ISO 9001:2008 standard.

LIMITED WARRANTY

OHAUS products are warranted against defects in materials and workmanship from the date of delivery through the duration of the warranty period. During the warranty period OHAUS will repair, or, at its option, replace any component(s) that proves to be defective at no charge, provided that the product is returned, freight prepaid, to OHAUS. This warranty does not apply if the product has been damaged by accident or misuse, exposed to radioactive or corrosive materials, has foreign material penetrating to the inside of the product, or as a result of service or modification by other than OHAUS. In lieu of a properly returned warranty registration card, the warranty period shall begin on the date of shipment to the authorized dealer. No other express or implied warranty is given by OHAUS Corporation. OHAUS Corporation shall not be liable for any consequential damages.

As warranty legislation differs from state to state and country to country, please contact OHAUS or your local OHAUS dealer for further details.



OHAUS Corporation
7 Campus Drive
Suite 310
Parsippany, NJ 07054 USA
Tel: +1 973 377 9000
Fax: +1 973 944 7177

With offices worldwide / Con oficinas alrededor del mundo / Avec des bureaux dans le monde entier / Weltweite Geschäftsstellen / Con uffici in tutto il mondo.

www.ohaus.com



* 3 0 0 3 7 4 5 3 *

P/N 30037453F © 2016 OHAUS Corporation, all rights reserved / todos los derechos reservados / tous droits réservés / Alle Rechte vorbehalten / tutti i diritti riservati.

Printed in China / Impreso en la China / Imprimé en Chine / Gedruckt in China / Stampato in Cina